

E2M TWO-STAGE ROTARY VANE PUMPS

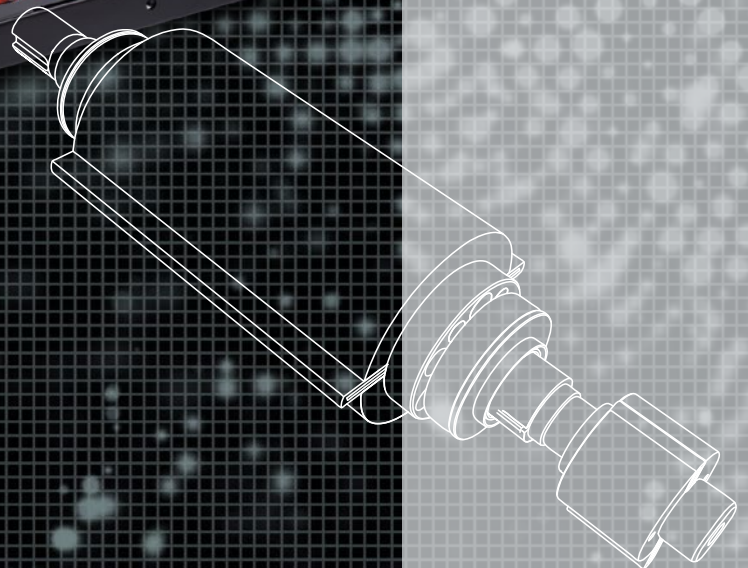
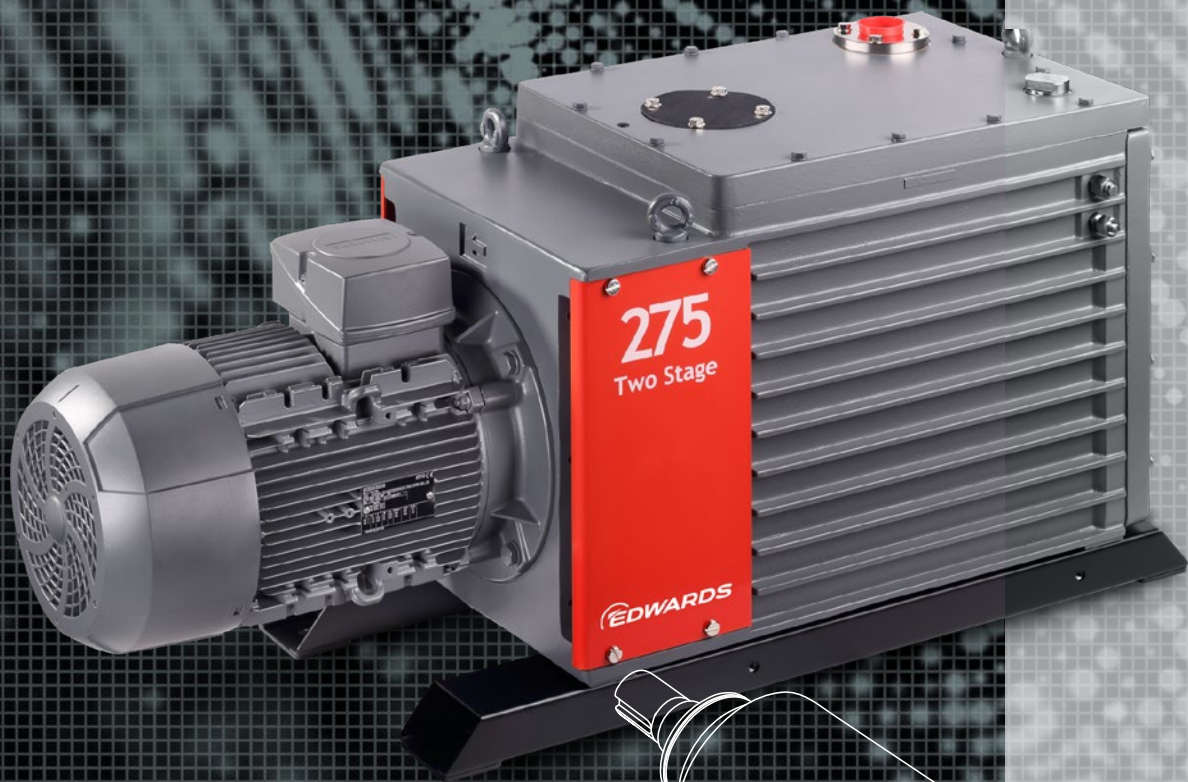

EDWARDS THE PARTNER OF CHOICE

Edwards is a world leader in the design, technology and manufacture of vacuum pumps for industrial applications with over 100 years' history.

We believe in delivering results that bring value to our customers by using our breadth of industry experience to identify and apply solutions. Using the most innovative and up-to date modelling techniques, we can optimise the pumping configuration for customers to provide a system design giving the maximum performance in the most reliable and cost-effective way.

E2M TWO-STAGE ROTARY VANE PUMPS

Industrial E2M vacuum pumps (40 to 275 m³/h) are rugged two-stage rotary vane pumps with a well-proven design. They feature advanced lubrication circuits to ensure smooth operation; and are available with optional heavy-duty accessories to suit a broad range of applications.

Specially designed for demanding applications, E2M pumps have demonstrated reliable long-term performance, are renowned for achieving low ultimate pressure and have high pumping speeds.

FEATURES & BENEFITS

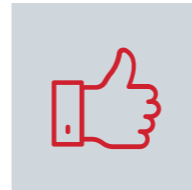

PEACE OF MIND

- With robust design and 30 years of proven performance in high-end markets
- Excellent sealing of the vacuum stage to maintain low and stable ultimate pressure
- Low surface temperature for maximum uptime
- Adjustable gas ballast for fine-tuning your process with built-in dust filter and purge gas connection



SAFE OPERATION

- Forced oil lubrication to ensure safe operation of the pump mechanism at any inlet pressure
- Smart oil distributor designed to ensure delivery of constant oil flow to the vacuum stage during operation. Internal oil pressure control possible with a pressure gauge
- Designed to prevent solid contamination with built-in oil filter. Additional external oil filtration possible

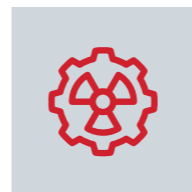

CONTAMINATION-FREE PROCESS

- Efficient inlet isolation valve to prevent oil suck-back
- Designed to prevent oil back-streaming
- Optional exhaust mist filters to capture oil vapours at the exhaust

E2M VARIANTS

HC

Standard pumps with hydrocarbon oil

AZ

Special variants free of yellow metals, Azide compatible

FX

PFPE prepared pumps for pumping oxygen mixtures with oxygen concentration >21%

EX

ATEX certified pumps for use in and with explosive atmospheres



E2M WITH EH BOOSTER COMBINATION

Combine the E2M with an EH booster to obtain additional pumping speed and improved ultimate pressure. Our unique pumping system EM275/EH4200 offers enormous suction speed to pump down large chambers quickly at very low pressure.

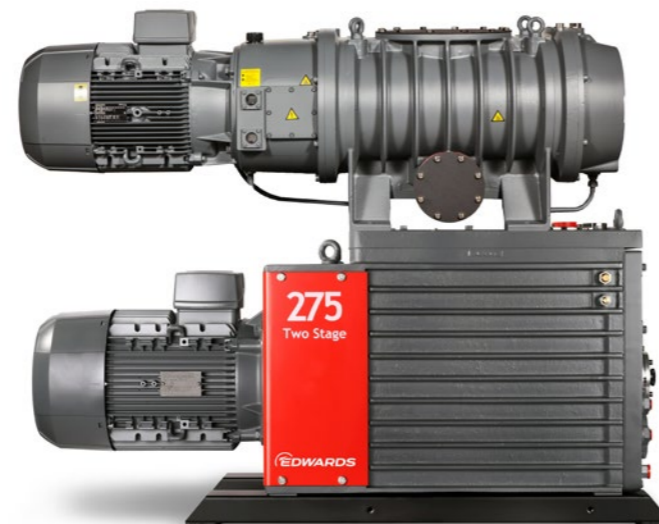

APPLICATIONS



- Coating
- Pharma freeze-drying (use AZ variant for Azide compatibility)
- Plasma treatments (use FX variant for oxygen-rich plasma compatibility)
- Heat pipes
- Heat treatments
- Chemical Process Industry (use EX variant for use in explosive atmospheres)

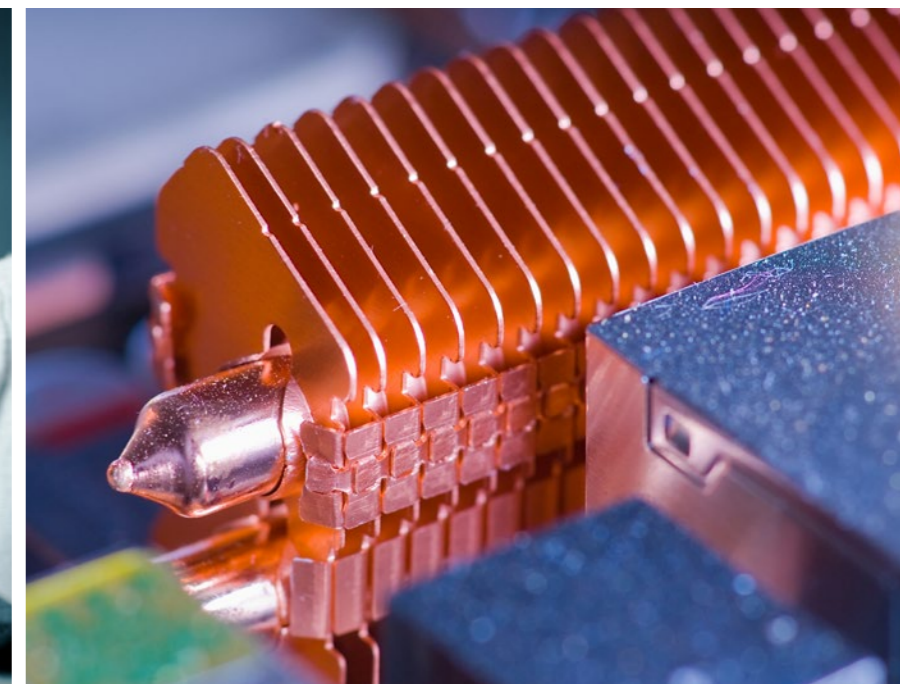
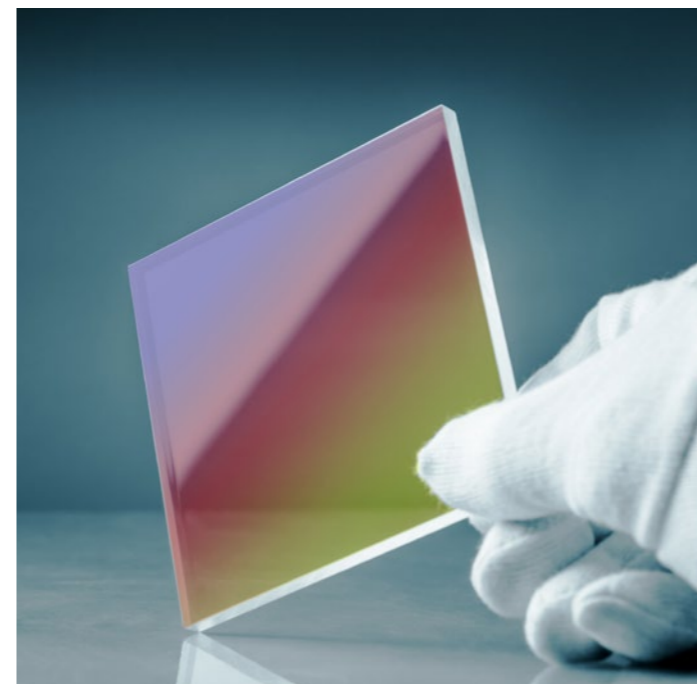

TECHNICAL DATA

		E2M 40	E2M 80	E2M 175	E2M 275
Max displacement (50 Hz)	m ³ h ⁻¹	42.5	80	175	292
Max displacement (60 Hz)	m ³ h ⁻¹	50.5	96	214	350
Pumping speed (50 Hz)	m ³ h ⁻¹	37	74	160	255
Pumping speed (60 Hz)	m ³ h ⁻¹	44	90	196	306
Ultimate total pressure without gas ballast	mbar	3.0E-03	3.0E-03	3.0E-03	3.0E-03
Ultimate vacuum with gas ballast	mbar	5.0E-03	5.0E-03	5.0E-03	5.0E-03
Inlet connection	ISO-F / NW	40	40	63	63
Outlet connection	NW	25	25	40	40
Max permitted outlet pressure	bar (g)	0.5	0.5	0.5	0.5
Max water vapour tolerance	mbar	7	5	4(20*)	2(12*)
Max water vapour capacity	kgh ⁻¹	0.2	0.3	2.4	2.5
Max gas ballast flow	m ³ h ⁻¹	1.7	1.4	3	3
Dimensions (LxWxH)	mm	780x240x395	889x266x429	1055x388x533	1165x388x533
Weight Approximate	Kg	75	104	198	216
Motor protection rating	IP	55	55	55	55
Motor rated power (50 Hz)	kW	1.1	2.2	5.5	7.5
Motor rated power (60 Hz)	kW	1.5	3	6.5	8.5
Noise level (50 Hz)	dB(A)	65	65	75	75
Oil refill capacity (Max)	litre	2.2/4	4/6.3	16/25	18/28
Recommended oil		Ultragrade 70 (E2M HC, AZ & EX) / PFPE lubricant (E2M FX)			

* with optional thermostatic water flow valve

PERFORMANCE CURVES

E2M40

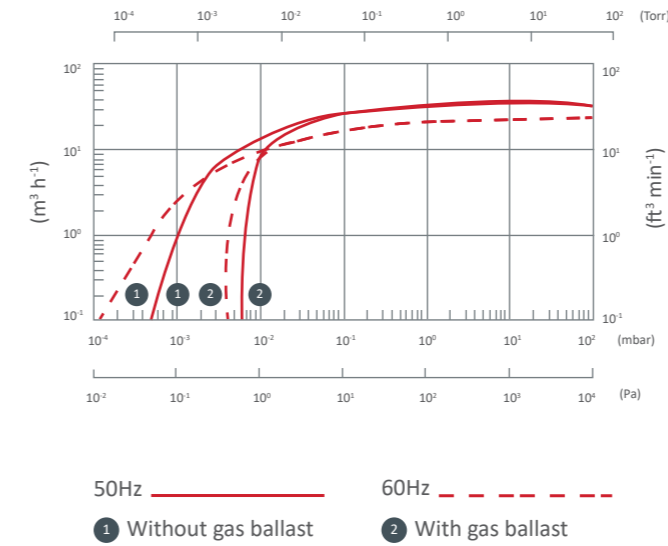

E2M80

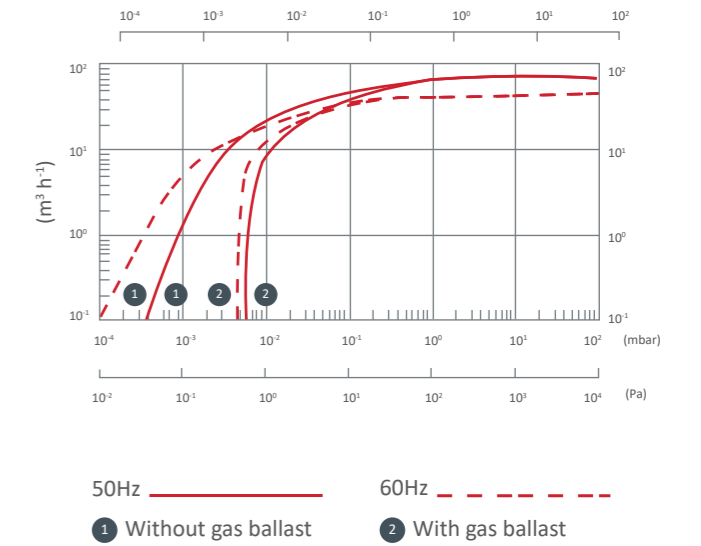

E2M175

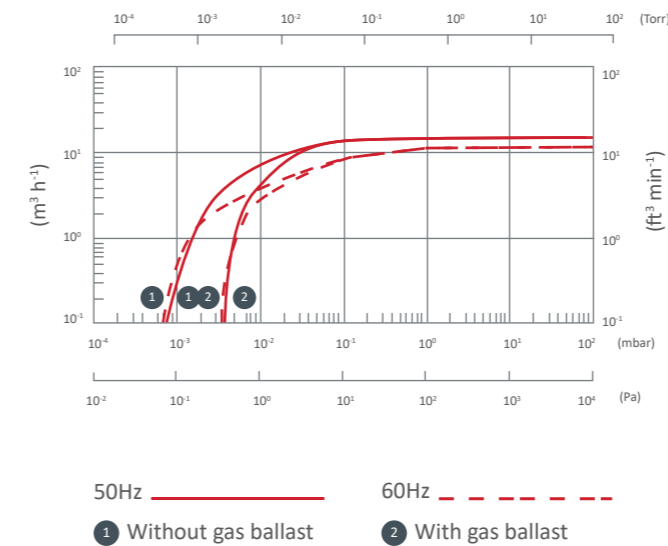

E2M275

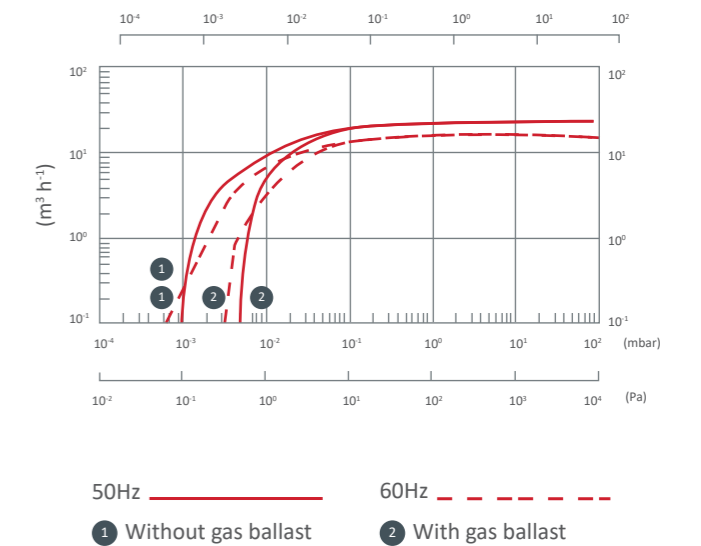

DIMENSIONS

E2M40

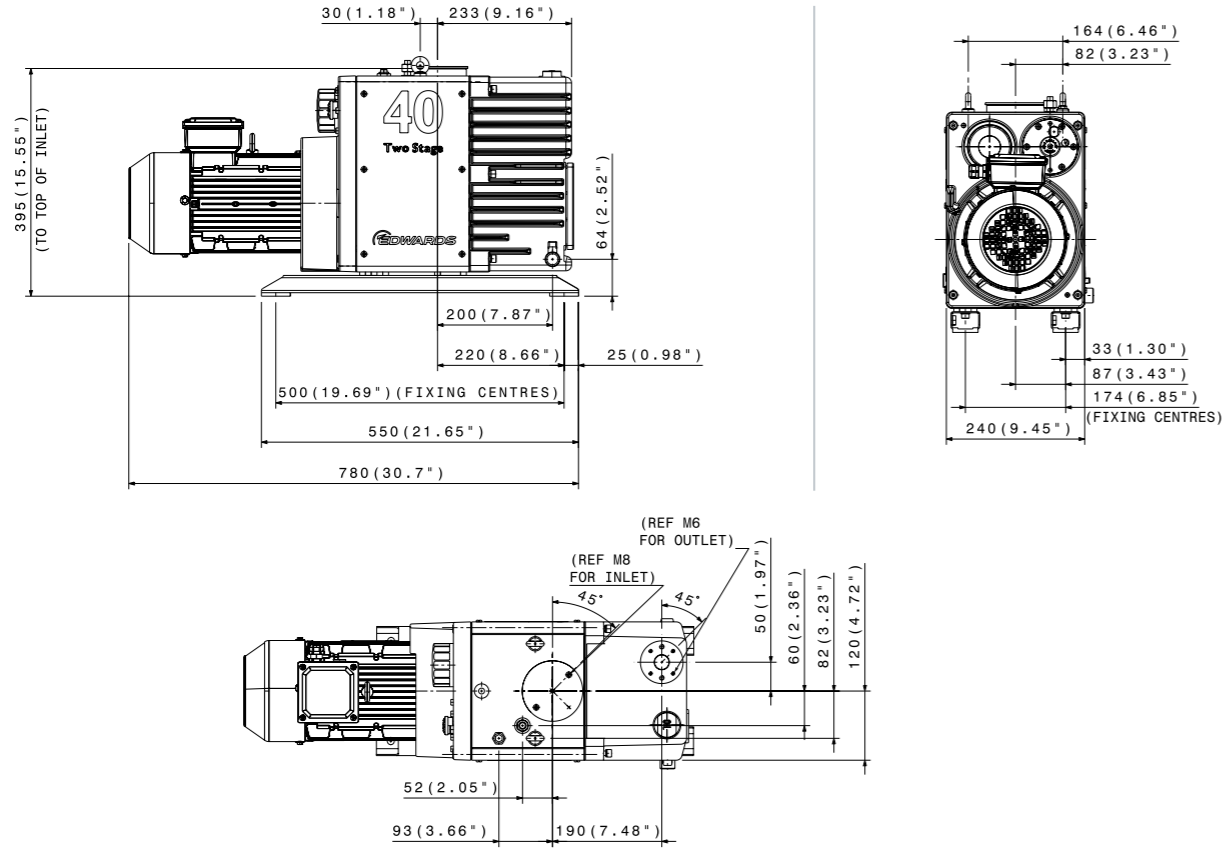

E2M175

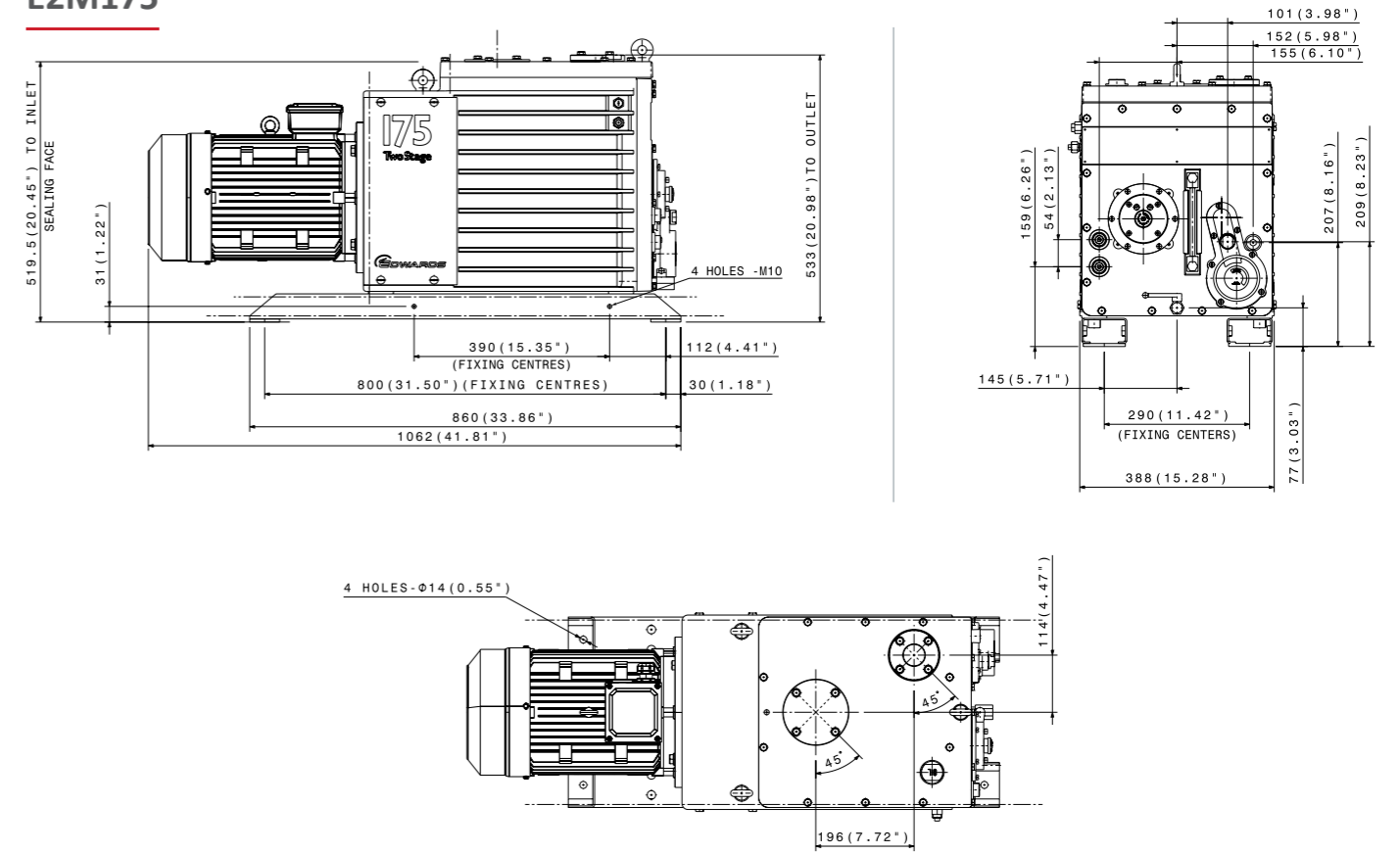

E2M80

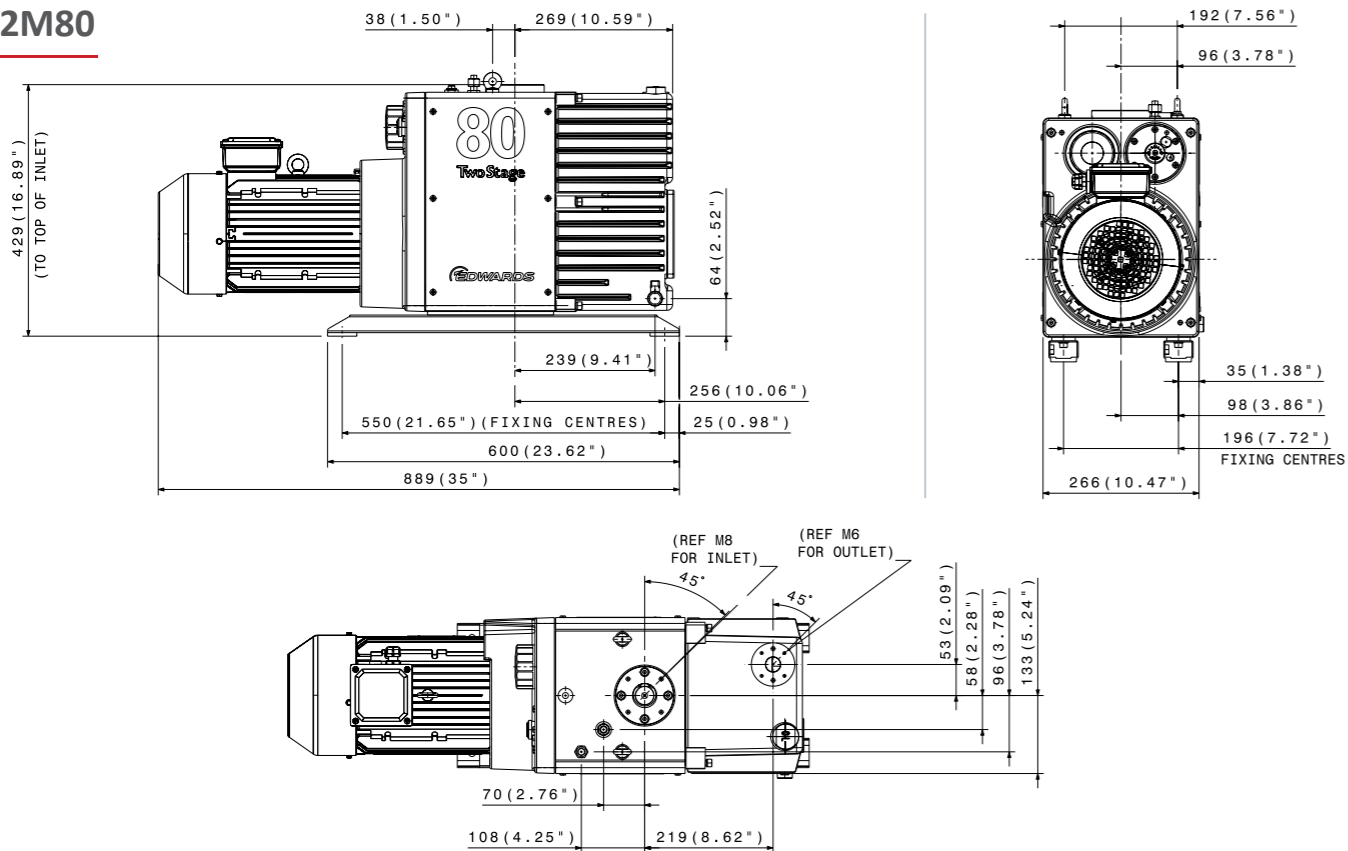

E2M275

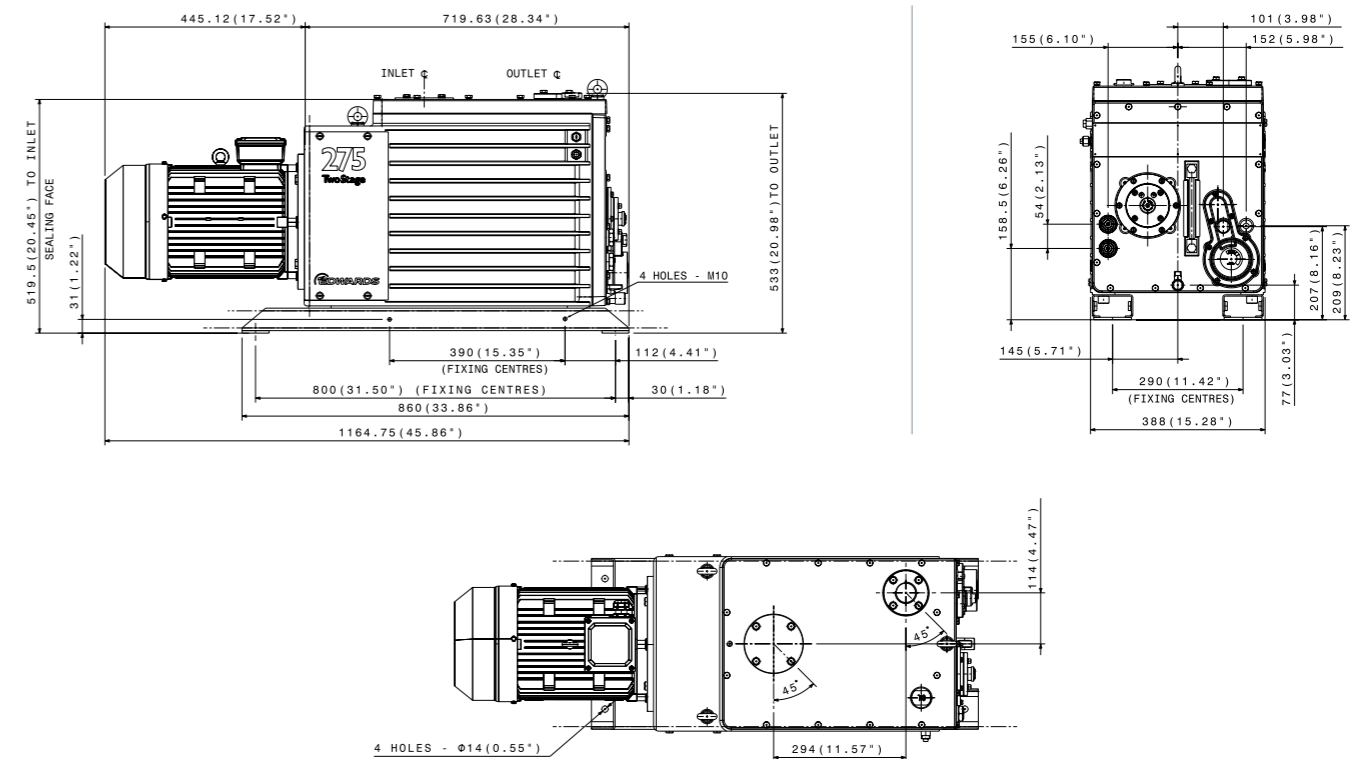

SERVICE AND SUPPORT

To ensure your pump maintains optimal performance and reliability, we offer a wide range of service solutions, tailored to meet your needs. From Field Service intervention to Managed Maintenance agreements, we will take care of your pump to ensure that it continues to deliver clean, consistent, efficient performance, with lower running cost and optimum total cost of ownership for its entire operating life.

Selecting original spare parts, maintenance kits and grease, means that every critical part performs as it was intended. Form, fit and function are guaranteed. Our services engineers only fit 100% genuine parts to ensure you receive the best result from each and every service.



ORDERING INFORMATION

Mat. Number	Description
E2M HC Series (standard pumps with hydrocarbon oil)	
A36404934	E2M 40 HC IE3 ASIA 50/60 Hz
A36504934	E2M 80 HC IE3 ASIA 50/60 Hz
A36604934	E2M 175 HC IE3 ASIA 50/60 Hz
A36704934	E2M 275 HC IE3 ASIA 50/60 Hz
A36404940	E2M 40 HC IE3 EU/US 50/60 Hz
A36504940	E2M 80 HC IE3 EU/US 50/60 Hz
A36604940	E2M 175 HC IE3 EU/US 50/60 Hz
A36704940	E2M 275 HC IE3 EU/US 50/60 Hz

Mat. Number	Description
E2M FX Series (compatible with oxygen concentration >21%)	
A36417934	E2M 40 FX IE3 ASIA 50/60 Hz
A36417940	E2M 40 FX IE3 EU/US 50/60 Hz
A36517934	E2M 80 FX IE3 ASIA 50/60 Hz
A36517940	E2M 80 FX IE3 EU/US 50/60 Hz
A36617934	E2M 175 FX IE3 ASIA 50/60 Hz
A36617940	E2M 175 FX IE3 EU/US 50/60 Hz
A36717934	E2M 275 FX IE3 ASIA 50/60 Hz
A36717940	E2M 275 FX IE3 EU/US 50/60 Hz

Note: PFPE lubricant to be purchased separately

Mat. Number	Description
E2M AZ Series (Azide compatible)	
A36407934	E2M 40 AZ IE3 ASIA 50/60 Hz
A36407940	E2M 40 AZ IE3 EU/US 50/60 Hz
A36507934	E2M 80 AZ IE3 ASIA 50/60 Hz
A36507940	E2M 80 AZ IE3 EU/US 50/60 Hz
A36607934	E2M 175 AZ IE3 ASIA 50/60 Hz
A36607940	E2M 175 AZ IE3 EU/US 50/60 Hz
A36707934	E2M 275 AZ IE3 ASIA 50/60 Hz
A36707940	E2M 275 AZ IE3 EU/US 50/60 Hz

Mat. Number	Description
E2M EX Series (ATEX cat 3 internal / cat 2 external)	
A36418993	E2M 40T4 220/240V or 380/415V 50 Hz 3Ø
A36518993	E2M 80T4 220/240V or 380/415V 50 Hz 3Ø
A36618993	E2M 175T3 220/240V or 380/415V 50 Hz 3Ø
A36718993	E2M 275T3 220/240V or 380/415V 50 Hz 3Ø

E2M ACCESSORIES

E2M 40/80		
A44202000	Inlet dust filter	ITF100
A44302000	High capacity inlet dust filter	ITM100
A44102000	Inlet catchpot	ITO100
A44402000	Inlet chemical trap	ITC100
A46203000	Outlet mist filter (clean)	MF100
A46211000	Outlet mist filter (toxic)	MF100AE
A50004000	Outlet mist filter oil return kit	
A46103000	Outlet catchpot	CP100
A50017930	Electric GB EM40/80	EBV300D
A24801405	Vibration isolators	

E2M175/275		
A44203000	Inlet dust filter	ITF300
A44303000	High capacity inlet dust filter	ITM300
A44103000	Inlet catchpot	ITO300
A44403000	Inlet chemical trap	ITC300
A46204000	Outlet mist filter (clean)	MF300
A50005000	Outlet mist filter oil return kit	
A46104000	Outlet catchpot	CP300
A24801406	Vibration isolators	
A50001000	Thermostatic valve	TCU300



GLOBAL CONTACTS

Publication Number: 3602 013 1 01

© Edwards Limited 2021. All rights reserved.
Edwards and the Edwards logo are trademarks of
Edwards Limited.

Whilst we make every effort to ensure that we
accurately describe our products and services,
we give no guarantee as to the accuracy or
completeness of any information provided in
this brochure.

Edwards Ltd., registered in England and Wales
No. 6124750, registered office: Innovation Drive,
Burgess Hill, West Sussex, RH15 9TW, UK.

EMEA

UK	+44 1444 253 000 (local rate) 08459 212223
Belgium	+44 1293 60 3350
France	+33 1 4121 1256
Germany	0800 000 1456
Italy	+ 39 02 48 4471
Israel	+ 972 8 681 0633
Russia	+7 495 933 55 50 Ext. 1800/1803 +8 800 775 80 99

ASIA PACIFIC

China	+86 400 111 9618
India	+91 20 4075 2222
Japan	+81 47 458 8836
Korea	+82 31 716 7070
Singapore	+65 6546 8408
Taiwan	+886 3758 1000

AMERICAS

USA	+1 800 848 9800
Brazil	+55 11 3952 5000